

# The Mystery of the Missing Umpire

## Wimbledon Maths Mystery Game

At this year's prestigious world tennis championships, the players are all prepared to challenge for the famous trophy. However, just as the last spectators are shown to their seats, disaster strikes. The umpire, who is needed to oversee the match, is missing! Immediately, all of the players spring into action and start looking for the missing umpire.

Can you solve the problems and reveal who discovers the whereabouts of the tennis umpire?



visit [twinkl.com](https://www.twinkl.com)

Player	Gender	Continent	Age	Kit Colour	Tennis Skill
Anna Avraham	Female	Asia	24	Red	Serve
Bailey Brown	Male	Europe	22	Green	Volley
Chow Chu	Female	Asia	20	White	Slice
Daniel Diaz	Male	South America	21	Blue	Speed
Elif Earl	Female	Australasia	27	Purple	Backhand
Felix Falade	Male	Africa	31	Black	Slice
George Gonzales	Male	North America	35	White	Serve
Harnam Hafeez	Female	Australasia	25	Green	Volley
India Ings	Female	Europe	30	Purple	Serve
Joshua Jelani	Male	Africa	21	White	Slice
Kuljeet Kimura	Female	Asia	23	Green	Volley
Li Lopez	Male	South America	24	Black	Speed
Matt Martin	Male	Australasia	34	Blue	Backhand
Nikita Naylor	Female	North America	31	Black	Slice
Odetta Otto	Female	Europe	30	Green	Serve
Preet Patel	Male	Asia	20	Purple	Volley
Queenie Quarrie	Female	Australasia	19	Blue	Backhand
Rehan Romero	Male	South America	23	White	Serve
Sophie Selassie	Female	Africa	22	Black	Speed
Thierry Toussaint	Male	Europe	32	Purple	Volley
Violet Vera	Female	North America	27	Blue	Speed
Wen Wu	Female	Asia	24	Black	Slice



**Clue 1: Calculating Angles**

Calculate the value of the angles marked A to I.

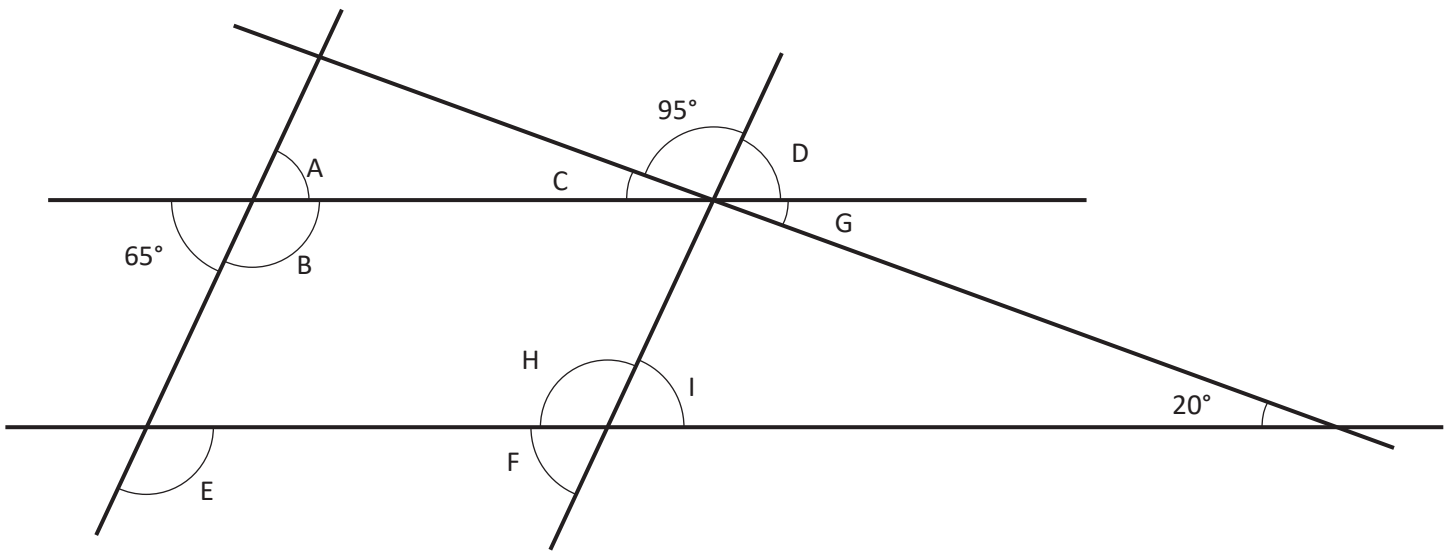

The solution that occurs the most will reveal a clue about who finds the umpire.

A =	B =	C =
D =	E =	F =
G =	H =	I =

65°	20°	115°
The player does not come from North America.	The player does not come from Europe.	The player does not come from Africa.

**Clue:** The player who finds the umpire doesn't come from \_\_\_\_\_.



**Clue 2: Arithmetic**

Find a path through the maze by following the correct arithmetic calculations. You can only move horizontally or vertically.

The path will reveal a clue about the player who finds the umpire.

<b>Start</b>	$406 - 9 = 397$	$36 \times 4 = 144$	$\frac{3}{9} + \frac{4}{9} = \frac{7}{9}$	$\frac{9}{10} - \frac{3}{10} = \frac{5}{10}$
$928 - 100 = 828$	$1019 + 392 = 1511$	$11 - 6.05 = 5.5$	$91 \div 7 = 13$	$6 \times 4 \times 3 = 75$
$178 \times 2 = 356$	$8.4 + 1.9 = 10.3$	$9.7 - 0.05 = 9.65$	$2508 + 3865 = 6374$	$90\,000 - 900 = 89\,100$
$307\,376 - 7298 = 135\,178$	$630 \div 9 = 7$	$7^2 = 49$	$1210 \div 11 = 12$	$1001 \times 1000 = 1\,001\,000$
$5150 \div 5 = 1030$	$13.7 - 3.84 = 9.86$	$7 \times 1\frac{1}{2} = 10\frac{1}{2}$	$57 \times 17 = 1069$	$\frac{1}{3} + \frac{1}{6} = \frac{1}{2}$
$(37 - 9) \div 4 = 7$	$\frac{1}{4} \times \frac{1}{3} = \frac{1}{7}$	$1.23 \times 8 = 8.84$	$\frac{3}{5} \div 3 = \frac{1}{5}$	20% of 140 = 28
The player's special skill is not speed or a backhand.	The player's special skill is not a backhand or slice.	The player's special skill is not speed or a slice.	The player's special skill is not a volley or backhand.	The player's special skill is not speed or a serve.

**Clue:** The skill of the player who finds the umpire isn't \_\_\_\_\_.

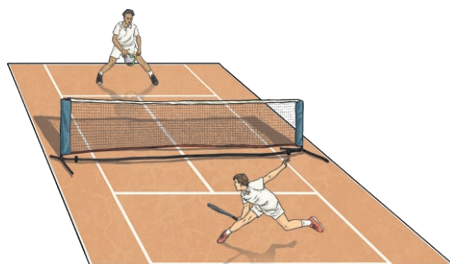

**Clue 3: Mean**

Find the mean of each set of numbers in the left-hand column and match them with the answers on the right.

The remaining answer box will give you a clue about the player who finds the umpire.

5, 6, 8, 3, 4
1, 7, 1, 7, 9
3, 3, 6, 3, 3
9, 7, 6, 8, 7
7, 4, 2, 2, 5
1, 6, 3, 7, 2
1, 10, 4, 3, 4
3, 6, 8, 1, 9

4.4	purple or white
5	black or blue
5.4	green or black
4	blue or purple
7.4	white or black
5.2	green or blue
4.2	green or white
3.8	black or purple
3.6	purple or green

**Clue:** The player who finds the umpire has a \_\_\_\_\_  
or \_\_\_\_\_ kit.

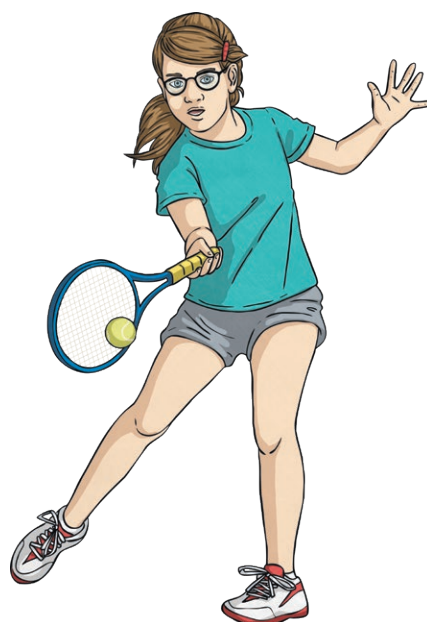

### Clue 4: Symmetry

Look at each reflection. If the shape has been reflected correctly, put a tick. If it has been reflected incorrectly, put a cross. Count the number of ticks and crosses.

If there are **more ticks than crosses**, the player who finds the umpire is **female**.

If there are **more crosses than ticks**, the player who finds the umpire is **male**.

(✓x) <input type="checkbox"/>	(✓x) <input type="checkbox"/>	(✓x) <input type="checkbox"/>
(✓x) <input type="checkbox"/>	(✓x) <input type="checkbox"/>	(✓x) <input type="checkbox"/>
(✓x) <input type="checkbox"/>	(✓x) <input type="checkbox"/>	(✓x) <input type="checkbox"/>

	✓	×
Total		

(Circle the correct answer.)

**Clue:** The player who finds the umpire is female/male.

**Clue 5: Coordinates**

On this coordinates grid, there are five quadrilaterals. The coordinates of each vertices have been written below but one of the written coordinates is incorrect.

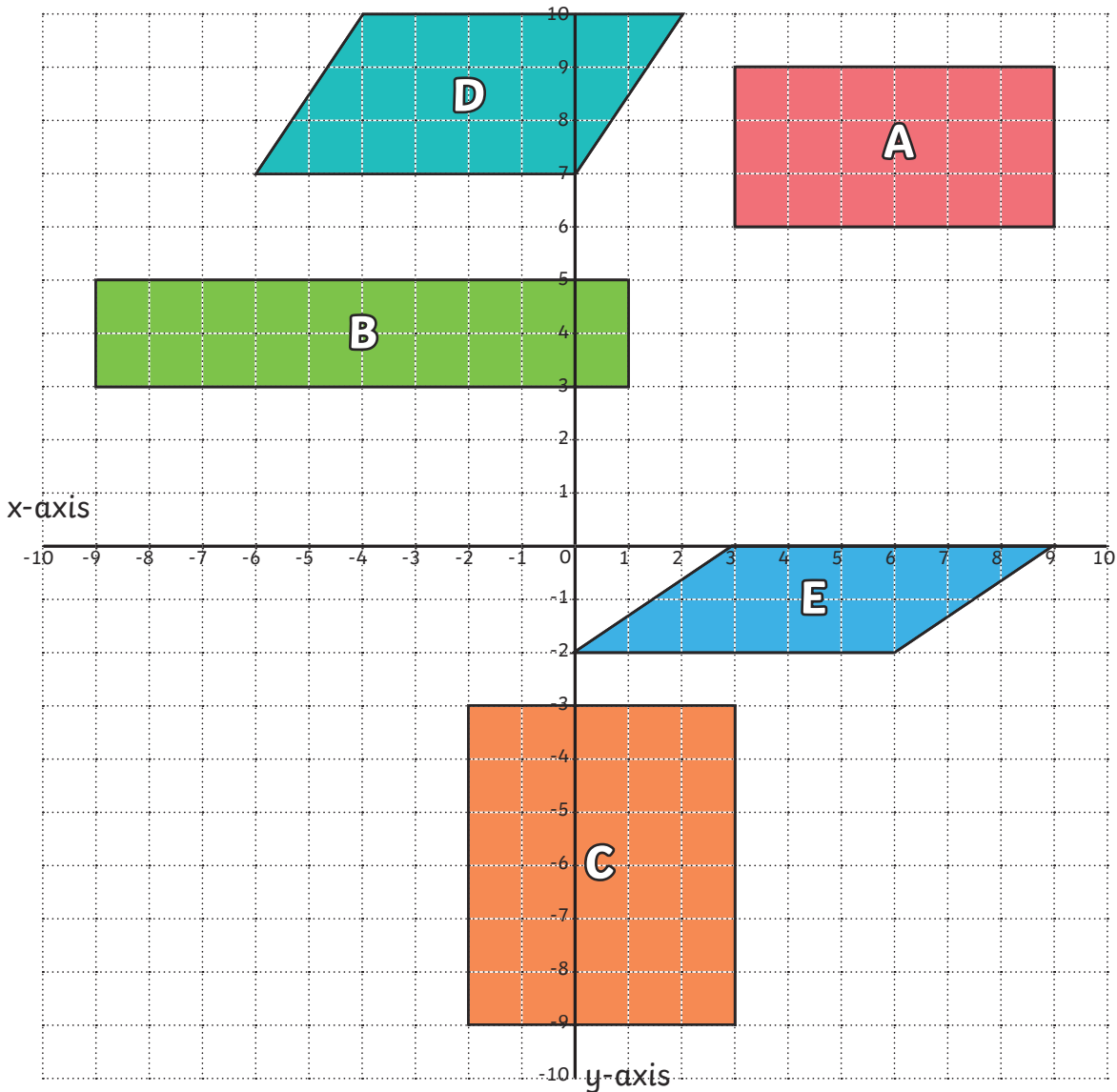

Circle the incorrect coordinates. The column with the most incorrect answers will tell you the age of the player who finds the umpire.

<b>A</b>	(3,6)	(9,6)	(9,8)	(3,9)
<b>B</b>	(-9,3)	(1,2)	(1,5)	(-9,5)
<b>C</b>	(3,-9)	(3,-3)	(-2,-3)	(-9,-2)
<b>D</b>	(7,0)	(2,10)	(-4,10)	(-6,7)
<b>E</b>	(0,-2)	(6,-2)	(8,0)	(3,0)
	<b>19-22</b>	<b>23-26</b>	<b>27-30</b>	<b>31-35</b>

**Clue:** The player who finds the umpire is aged \_\_\_\_\_.

The player who was responsible for finding the umpire is \_\_\_\_\_.

## Clue 1: Calculating Angles

Calculate the value of the angles marked A to I.

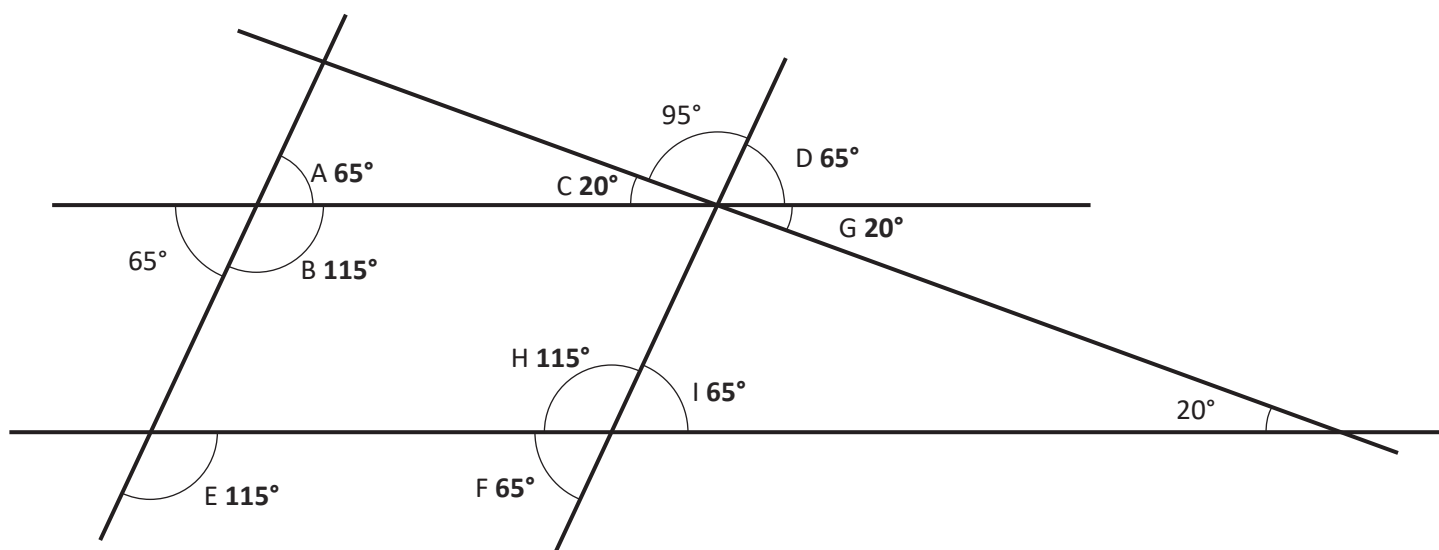

The solution that occurs the most will reveal a clue about who finds the umpire.

A = 65°	B = 115°	C = 20°
D = 65°	E = 115°	F = 65°
G = 20°	H = 115°	I = 65°

65°	20°	115°
<b>The player does not come from North America.</b>	The player does not come from Europe.	The player does not come from Africa.

**Clue:** The player who finds the umpire doesn't come from North America.



## Clue 2: Arithmetic

Find a path through the maze by following the correct arithmetic calculations. You can only move horizontally or vertically.

The path will reveal a clue about the player who finds the umpire.

<b>Start</b>	$406 - 9 = 397$	$36 \times 4 = 144$	$\frac{3}{9} + \frac{4}{9} = \frac{7}{9}$	$\frac{9}{10} - \frac{3}{10} = \frac{5}{10}$
$928 - 100 = 828$	$1019 + 392 = 1511$	$11 - 6.05 = 5.5$	$91 \div 7 = 13$	$6 \times 4 \times 3 = 75$
$178 \times 2 = 356$	$8.4 + 1.9 = 10.3$	$9.7 - 0.05 = 9.65$	$2508 + 3865 = 6374$	$90\,000 - 900 = 89\,100$
$307\,376 - 7298 = 135\,178$	$630 \div 9 = 7$	$7^2 = 49$	$1210 \div 11 = 12$	$1001 \times 1000 = 1\,001\,000$
$5150 \div 5 = 1030$	$13.7 - 3.84 = 9.86$	$7 \times 1\frac{1}{2} = 10\frac{1}{2}$	$57 \times 17 = 1069$	$\frac{1}{3} + \frac{1}{6} = \frac{1}{2}$
$(37 - 9) \div 4 = 7$	$\frac{1}{4} \times \frac{1}{3} = \frac{1}{7}$	$1.23 \times 8 = 8.84$	$\frac{3}{5} \div 3 = \frac{1}{5}$	20% of 140 = 28
The player's special skill is not speed or a backhand.	The player's special skill is not a backhand or slice.	The player's special skill is not speed or a slice.	The player's special skill is not a volley or backhand.	The player's special skill is not speed or a serve.

**Clue:** The skill of the player who finds the umpire isn't speed or a backhand.

### Clue 3: Mean

Find the mean of each set of numbers in the left-hand column and match them with the answers on the right.

The remaining answer box will give you a clue about the player who finds the umpire.

5, 6, 8, 3, 4	4.4	purple or white
1, 7, 1, 7, 9	5	black or blue
3, 3, 6, 3, 3	5.4	green or black
9, 7, 6, 8, 7	4	blue or purple
7, 4, 2, 2, 5	7.4	white or black
1, 6, 3, 7, 2	5.2	green or blue
1, 10, 4, 3, 4	4.2	green or white
3, 6, 8, 1, 9	3.8	black or purple
	3.6	purple or green

**Clue:** The player who finds the umpire has a green  
or white kit.

## Clue 4: Symmetry

Look at each reflection. If the shape has been reflected correctly, put a tick. If it has been reflected incorrectly, put a cross. Count the number of ticks and crosses.

If there are **more ticks than crosses**, the player who finds the umpire is **female**.

If there are **more crosses than ticks**, the player who finds the umpire is **male**.

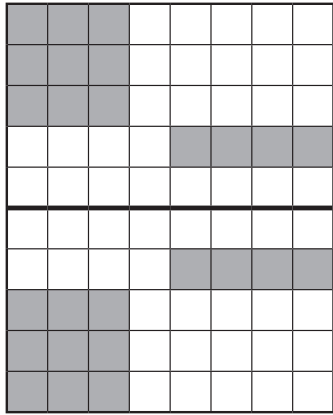

(✓x)

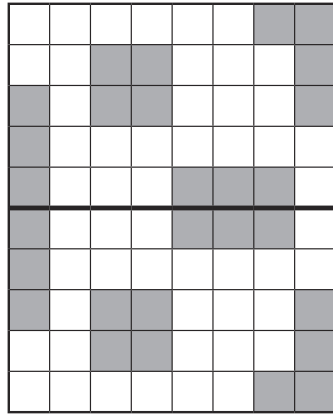

(✓x)

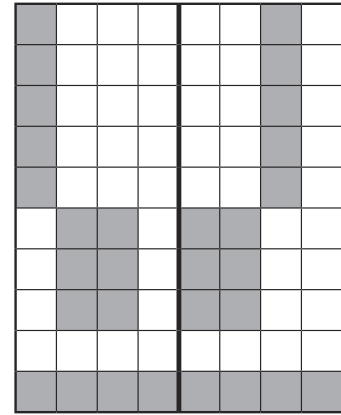

(✓x)

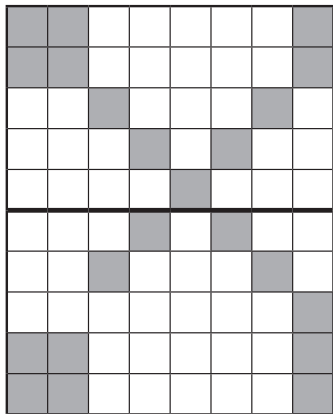

(✓x)

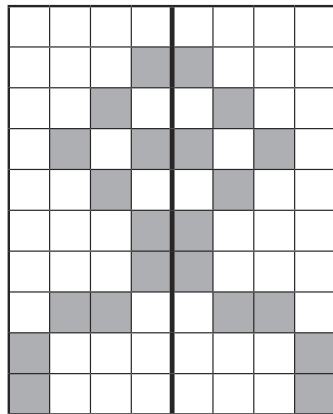

(✓x)

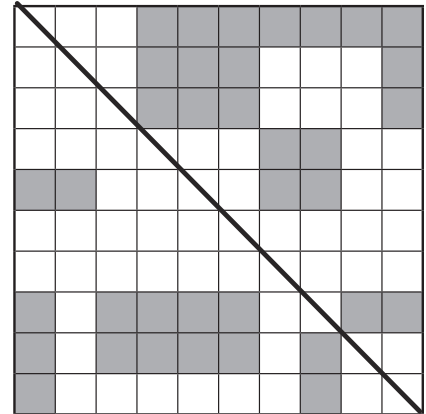

(✓x)

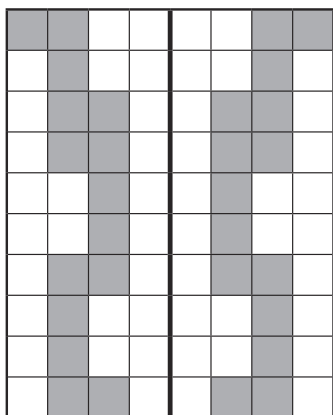

(✓x)

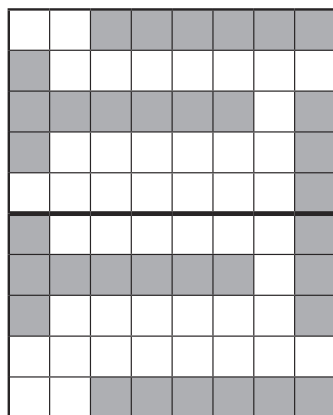

(✓x)

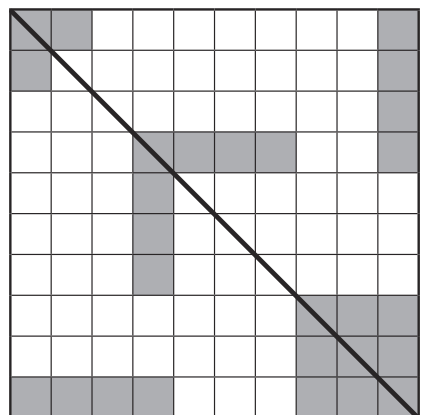

(✓x)

	✓	×
Total	5	4

(Circle the correct answer.)

Clue: The player who finds the umpire is female/male.

## Clue 5: Coordinates

On this coordinates grid, there are five quadrilaterals. The coordinates of each vertices have been written below but one of the written coordinates is incorrect.

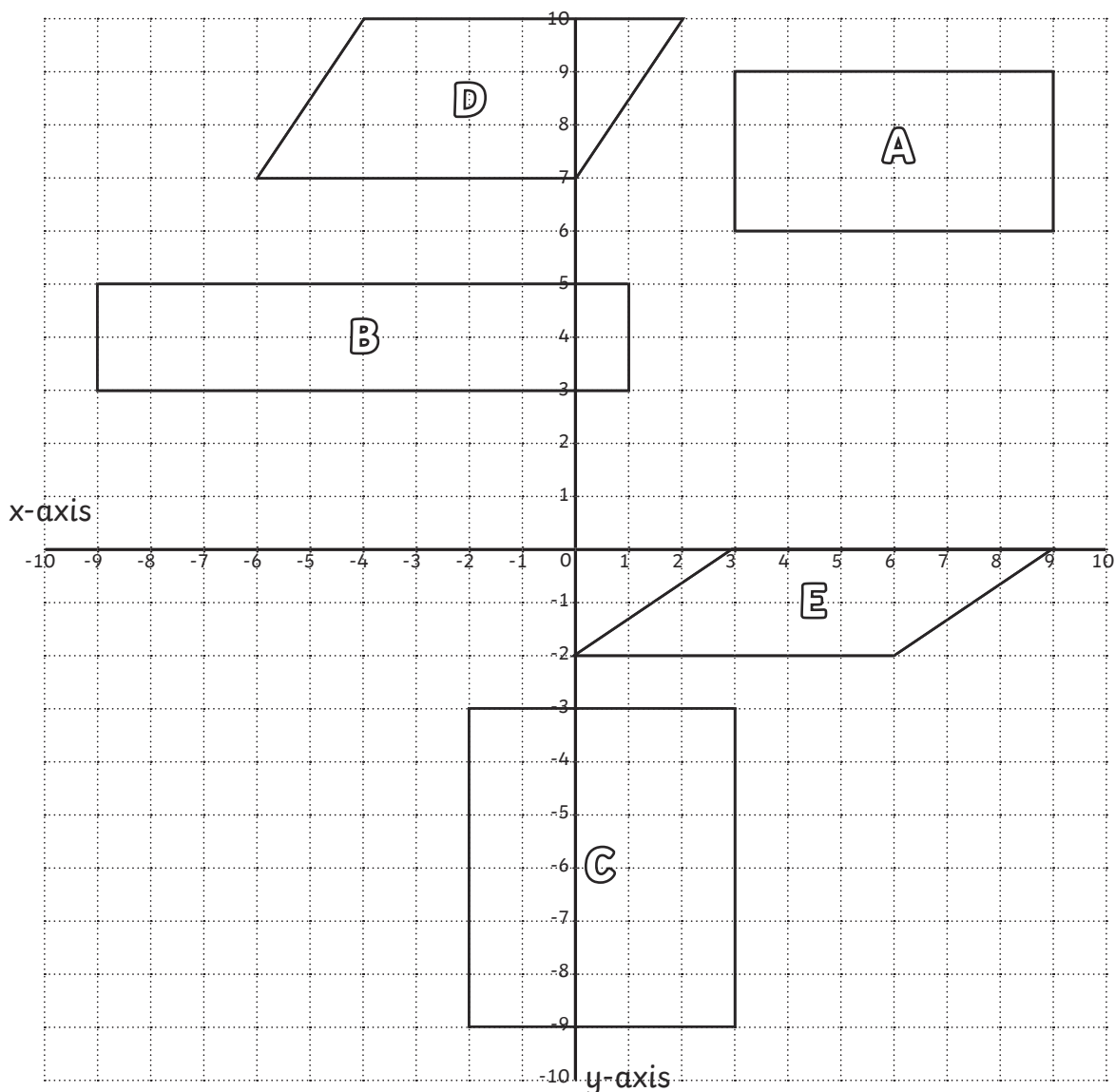

Circle the incorrect coordinates. The column with the most incorrect answers will tell you the age of the player who finds the umpire.

<b>A</b>	(3,6)	(9,6)	<input type="checkbox"/> (9,8)	(3,9)
<b>B</b>	(-9,3)	<input type="checkbox"/> (1,2)	(1,5)	(-9,5)
<b>C</b>	(3,-9)	(3,-3)	(-2,-3)	<input type="checkbox"/> (-9,-2)
<b>D</b>	<input type="checkbox"/> (7,0)	(2,10)	(-4,10)	(-6,7)
<b>E</b>	(0,-2)	(6,-2)	<input type="checkbox"/> (8,0)	(3,0)
	19-22	23-26	<b>27-30</b>	31-35

(Circle the correct answer.)

**Clue:** The player who finds the umpire is aged **27-30**.

The player who was responsible for finding the umpire is Odetta Otto.